



CAMBRIDGE HISTORICAL COMMISSION

831 Massachusetts Avenue, 2nd Fl., Cambridge, Massachusetts 02139
Telephone: 617 349 4683 TTY: 617 349 6112
E-mail: histcomm@cambridgema.gov URL: www.cambridgema.gov/Historic

APPLICATION FOR CERTIFICATE

1. The undersigned hereby applies to the Cambridge Historical Commission for a Certificate of (check one box): Appropriateness, Nonapplicability, or Hardship, in accordance with Chapter 40C of the Massachusetts General Laws and/or Chapter 2.78 of the Municipal Code.
2. Address of property: 1 ARSENAL SQUARE, Cambridge, Massachusetts
3. Describe the proposed alteration(s), construction or demolition in the space provided below:
(An additional page can be attached, if necessary).

TO REPLACE ALL THE REMAINING SINGLE PANE WINDOWS ON THE 1ST & 2ND FL. WITH VINYL REPLACEMENTS WINDOW THAT LOOK SIMILAR IN NATURE. THE INTENT IS TO REMOVE THE INTERIOR STOPS ONLY IN ORDER TO REMOVE THE WOOD SASH AND REINSTALL THE STOPS ONCE THE SIMILAR LOOKING VINYL WINDOW IS INSTALLED. WE WOULD ATTEMPT TO USE THE SAME COLOR AND GRID PATTERN.

I certify that the information contained herein is true and accurate to the best of my knowledge and belief. The undersigned also attests that he/she has read the statements printed on the reverse.

Name of Property Owner of Record: <u>Ted Cassely, Managing Agent</u>	
Mailing Address: <u>2000 Commonwealth Ave, Auburndale, Ma. 02466</u>	
Telephone/Fax: <u>617-277-1805</u>	E-mail: <u>Ted@specializedhousing.org</u>
⇒ Signature of Property Owner of Record: <u>Ted Cassely</u> (Required field; the application will not be considered complete without the property owner's signature)	
Name of proponent, if not record owner: <u>Dennis Mills</u>	
Mailing Address: <u>4 JACOBS ST PEABODY MA 01960</u>	
Telephone/Fax: <u>781 228 0370</u>	E-mail: <u>DKS@KSOZCARPENTRY.COM KSOZCARPENTRY@SMITH.COM</u>

(for office use only):	
Date Application Received: _____	Case Number: <u>4955</u> Hearing Date: <u>5/11/23</u>
Type of Certificate Issued: _____	Date Issued: _____

Cambridge, Massachusetts

Google Street View

Aug 2019

See more dates



Image capture: Aug 2019 © 2023 Google





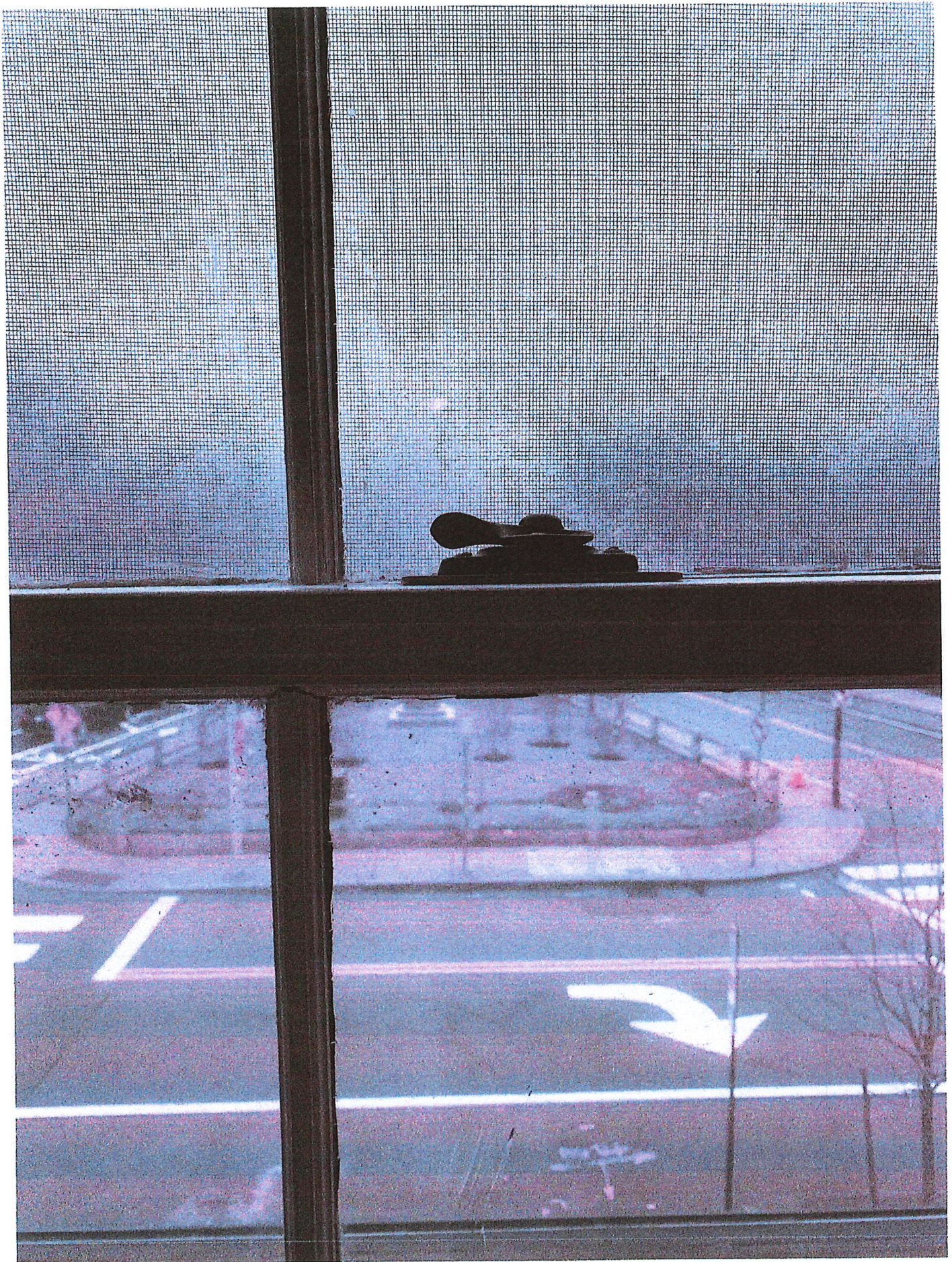

5320

Mar 21, 2023

1

KSO Carpentry
Dennis Mills
4 Jacobs Street
Peabody, MA 01960

781-228-0370

KSO CARPENTRY

PAYNE

Robin Harrington

GLASS AMERICA

C.O.D.

CHELSEA REPLACEMENT
EURO WHITE DOUBLE HUNG
LOW-E w/ARGON
1/2 SCREEN, NO GRIDS

1.00

33 1/2 X 64 1/2

0.00

Thank you for your continued business!
A 5% Credit card convenience fee will be applied to orders at time of payment

0.00

SALES ARE FINAL - NO RETURNS OR EXCHANGES!

0.00

Harvey Building Products
 Tribute Double Hung
 Replacement Frame
 Triple Glazed
 (1/2 Scale)

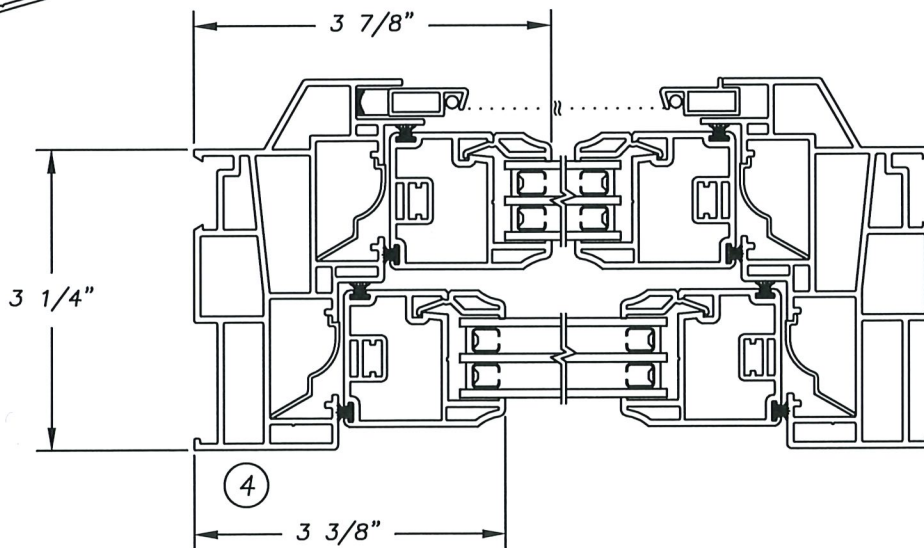
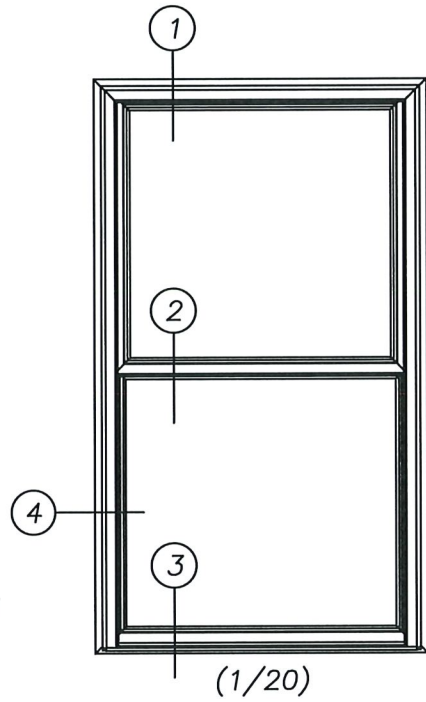
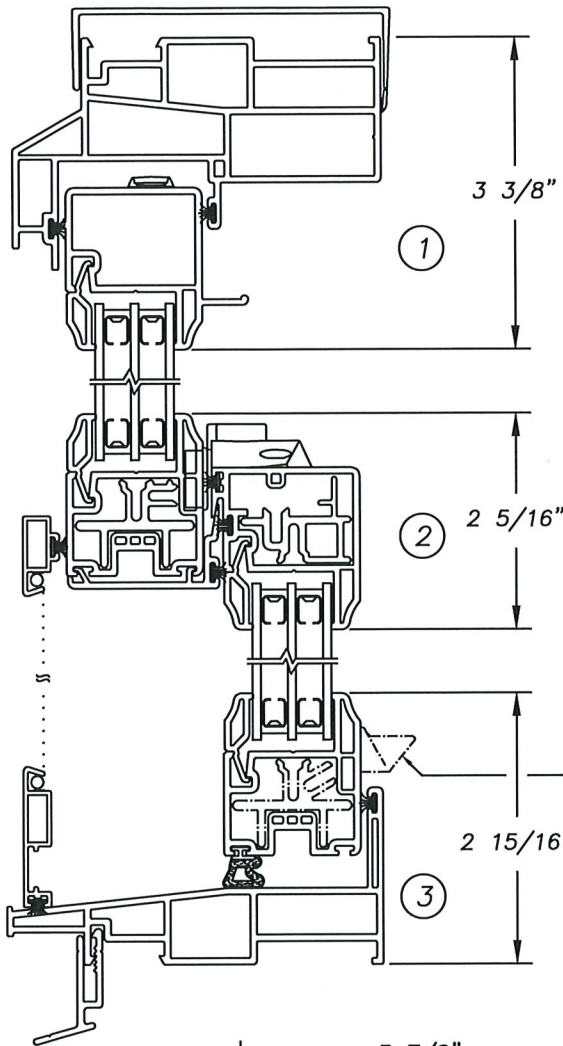

Burks, Sarah

From: Dennis Mills <kso1carpentry@gmail.com>
Sent: Wednesday, April 19, 2023 4:28 PM
To: Burks, Sarah; Ted Cassely
Subject: Fwd: Scanned document from HP ePrint user
Attachments: HPSCAN_20230419201352174_2023-04-19_201710686.pdf

Good Afternoon,

Following our meeting I have reached out to my distributor at Lansing Building Products who specializes in Harvey Windows.

I have concluded that they actually do offer a triple pane window with the grids on the exterior like you had specified. Here you will find a copy of the product log and spec sheet for your reference.

They do seem to be \$125 more each then what i had been paying from another manufacturer but i will try to apply for additional funding with the LEAN program so that the Historic Commision is only responsible for deciding on the outcome of the replacement and not for a grant.

Thanks

Dennis

--

Dennis Mills
K.S.O Carpentry
781-228-0370



HARVEY
WINDOWS + DOORS

TRIBUTE

Double Hung



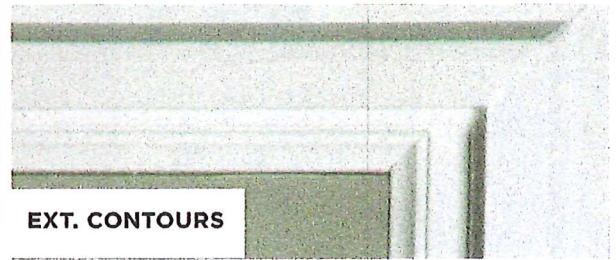
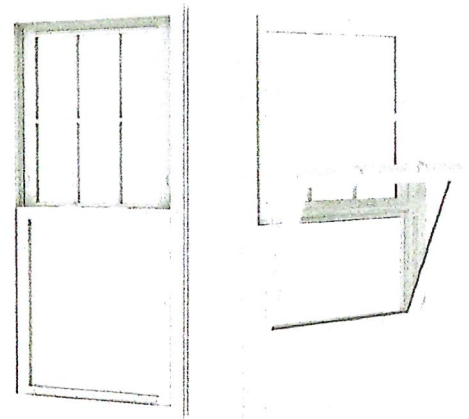
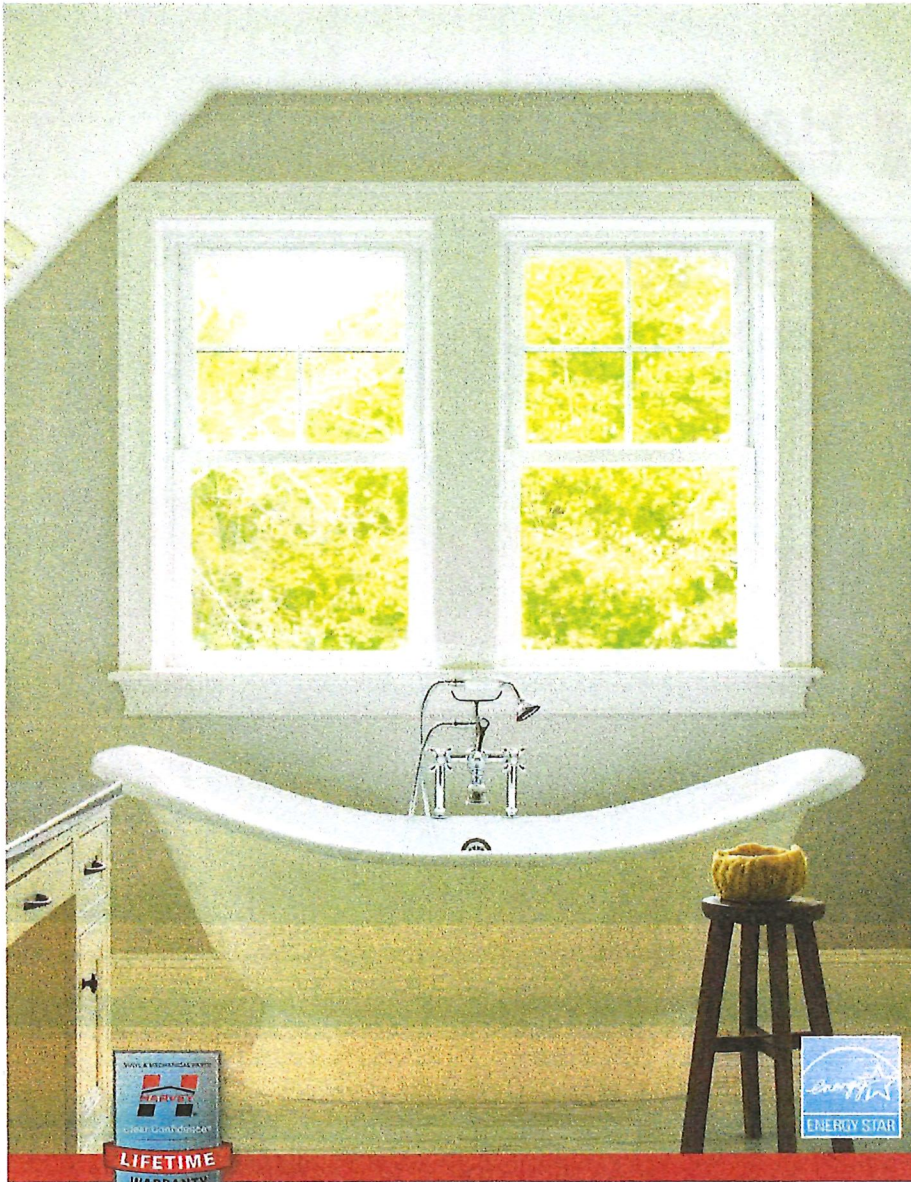

EXT. CONTOURS



INT. CONTOURS

The Harvey Tribute double hung provides superior energy efficiency and stunning good looks. The Tribute is fusion welded with a contoured sash and beveled edges to emulate the traditional look of a wood window. Harvey's revolutionary dual action lock/tilt latch combo gives the Tribute clean lines, with no exposed tilt latches to block your view.

LIFT HANDLE TYPES

Applied

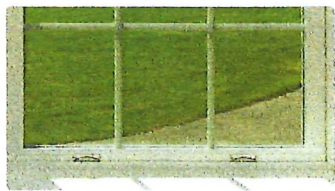

Integral



None



Lock

Tribute comes with double low profile sash locks, in three finishes, to complement its sleek design. Dual action means you can lock and tilt open the window with a flip of the thumb. Add matching applied lift handle for an upgraded appearance.



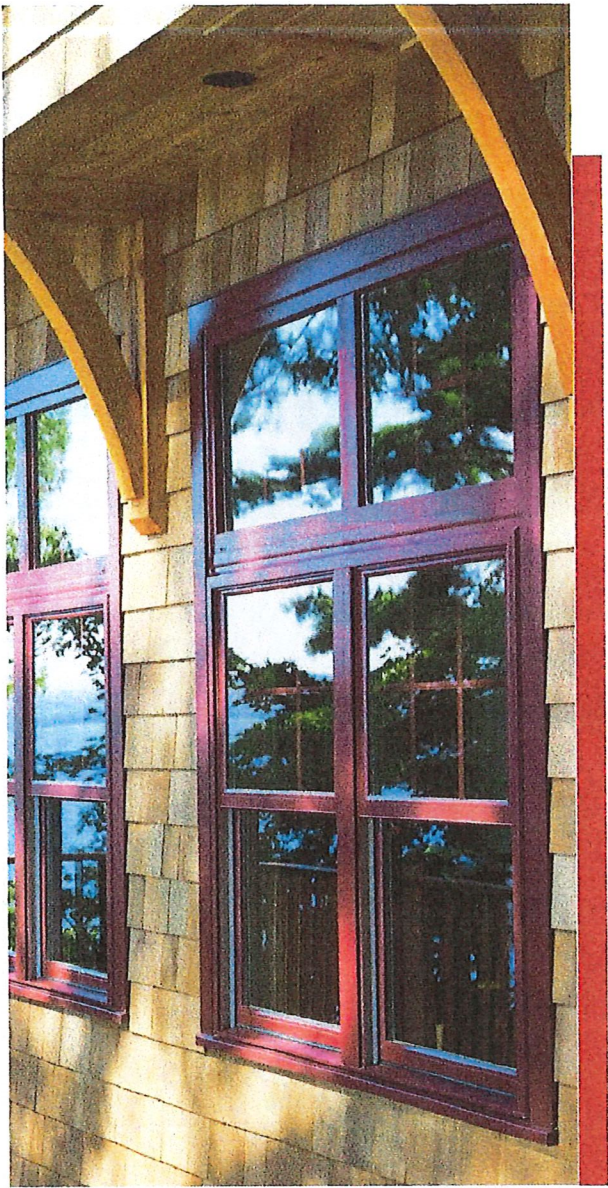

Options

ENERGY STAR GLASS



ThermoLock
ThermoLock 3X HPTG



SunGain
HSHG



ThermoGuard

SCREEN | FRAME



FlexScreen

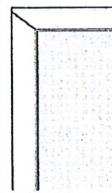

Aluminum

SCREEN | MESH

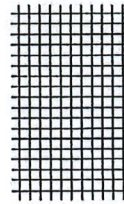

IEWS

GRID | TYPE



GBG



Exterior
Applied



SDL

GRID | STYLE

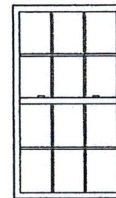

Colonial

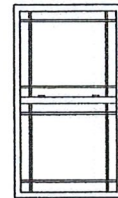

Prairie

MORE OPTIONS & FEATURES

Grids come in 5/8" and 1" sizes

Custom grid configurations plus oriel & cottage sash options

Full and half size screens

Sash/glazing bead contours and Simulated Divided Lite grids could help meet historic requirements when remodeling

Both sashes tilt in for cleaning; premium ventilation limit latches keep top or bottom sash partially open

COLORS | EXTERIOR



White Vinyl
(Standard)



COLORS | HARDWARE



White
(Standard)



Oil Rubbed
Bronze



Brushed
Nickel

WITH HARVEY, YOU GET PEACE OF MIND, STANDARD.

Clear Confidence

For nearly 60 years, we've built our reputation on the outstanding craftsmanship of our products and our world class customer service. You can rest easy knowing that most Harvey windows are backed by our Clear Confidence Warranty and that our commitment lasts a lifetime.

Claims

Warranties provided by Harvey are for product parts and mechanisms; they do not cover damages resulting from improper installation nor do they cover labor charges.

Please see actual warranty for details.

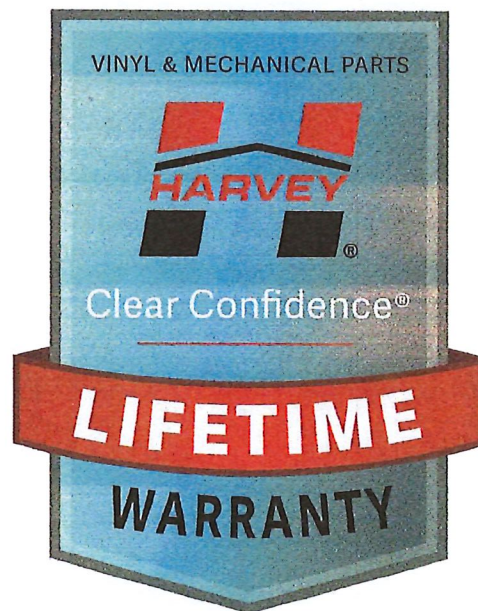

20 YEARS
GLASS SEAL

20 YEARS
TRANSFERABILITY

CLEAR:

Your windows are warrantied for life on any defects in structure, parts, and mechanisms, and for 20 years on interior glass seal failures.

CONFIDENCE:

We are confident in the quality of our products, but if something's not quite right, you can count on our highly trained, US-based customer support specialists and field technicians to solve your issue over the phone or at your property if needed.

CONVENIENT:

We make receiving replacement parts easy, including full sash replacements for glass repairs—no professional glass installer needed.

e. ~~ThermaLock 3X No Grids: U-Factor~~
~~0.24/ R-Value 4.16/ SHGc 0.24/ VT~~
~~0.44.~~

f. ~~ThermaLock 3X With Grids: U-Factor~~
~~0.24/ R-Value 4.16/ SHGc 0.21/ VT~~
~~0.39.~~

g. ~~SunGain No Grids U-Factor 0.31/ R-~~
~~Value 3.22/ SHGc 0.48/ VT 0.53.~~

h. ~~SunGain With Grids U-Factor 0.31/~~
~~R-Value 3.22/ SHGc 0.43/ VT 0.51.~~

2.16

REPLACEMENT TRIBUTE DOUBLE HUNG WINDOWS

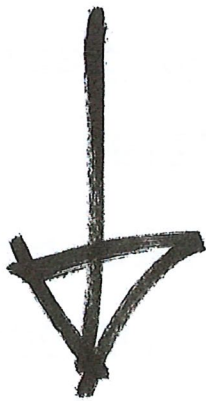

A. Construction:

1. Frame: 0.065 inch (1.7 mm) thick polyvinyl chloride (PVC). Miter cut and fusion welded corners. Contoured Sash

Design: 0.070 inch (1.8 mm) thick.

Fusion welded corners.

**** NOTE TO SPECIFIER **** White is standard. Custom Colors are available. Delete color options not required.

2. Color: White Vinyl.
3. Color: White Vinyl with Dark Bronze Exterior Finish - Painted.
4. Color: White Vinyl with Black Exterior Finish - Painted.
5. Color: Custom Exterior Finish - Painted. As determined by the Architect.
6. Glazing: Insulating glass units are silicone glazed with an exterior glazing bead. Complies with ASTM E2190.
7. Sash Balances: Factory calibrated block and tackle, complying with AAMA-902. Balance cords shall be anchored to locking terminal housings that lock in

place when the sash is tilted in. The locking terminal and pivot bar system shall provide accurate alignment of the sash and the frame during operation.

8. Two Sash Locks: unique low profile locks operate the tilt release latches allowing the sash to tilt-in.
9. Weather Stripping: In compliance with AAMA 701.2.

**** NOTE TO SPECIFIER ** Delete screens options not required.**

10. Screens: Extruded aluminum locking half screen. 16 x 16 VIEWS (Virtually Invisible Enhanced Window Screen) mesh.

11. Screens: Extruded aluminum full screen. 16 x 16 VIEWS (Virtually Invisible Enhanced Window Screen) mesh.

12. Screens: Premium FlexScreen full screen (Standard on Exterior Painted)

13. Screens: Premium FlexScreen half screen (Standard on Exterior Painted)

**** NOTE TO SPECIFIER ** Delete grids options not required.**

14. Grids: 5/8 inch (16 mm) Colonial contour grids between glass (GBG) dividers.

15. Grids: 1 inch (25 mm) Colonial contour grids between glass (GBG) dividers.

16. Grids: 5/8 inch (16 mm) SDL (Simulated Divided Lites).

17. Grids: 1 inch (25 mm) SDL (Simulated Divided Lites).

B. Performance:

**** NOTE TO SPECIFIER ** Delete structural rating option not required.**

1. Structural Rating: H-LC35 (DP35) - Test Size: 48 inches x 84 inches (1219 mm x 2134 mm) in accordance with AAMA/WDMA/CSA 101/I.S.2/A440-05.
2. Structural Rating: H-LC50 (DP50) - Test Size: 42 inches x 77 inches (1067 mm x 1956 mm) in accordance with AAMA/WDMA/CSA 101/I.S.2/A440-05.
3. Forced Entry: Type A, Grade 10 in accordance with ASTM F 588-97.
4. Glazing Type: Thermal transmittance in accordance with NFRC 100/200/500.

**** NOTE TO SPECIFIER ** Delete glazing type options not required.**

- a. ThermaGuard No Grids U-Factor 0.29/ R-Value 3.44/ SHGc 0.30/ VT 0.53.
- b. ThermaGuard With Grids U-Factor 0.29/ R-Value 3.44/ SHGc 0.27/ VT

0.47.

- c. ThermaLock RS No Grids: U-Factor 0.25/ R-Value 4.00/ SHGc 0.29/ VT 0.52.
- d. ThermaLock RS With Grids: U-Factor 0.25/ R-Value 4.00/ SHGc 0.26/ VT 0.46.
- e. ThermaLock 3X No Grids: U-Factor 0.21/ R-Value 4.76/ SHGc 0.24/ VT 0.44.
- f. ThermaLock 3X With Grids: U-Factor 0.22/ R-Value 4.54/ SHGc 0.21/ VT 0.39.
- g. SunGain No Grids U-Factor 0.30/ R-Value 3.33/ SHGc 0.48/ VT 0.58.
- h. SunGain With Grids U-Factor 0.30/ R-Value 3.33/ SHGc 0.43/ VT 0.51.

2.17 REPLACEMENT CLASSIC DOUBLE HUNG WINDOWS

A. Construction:

1. Frame: 0.065 inch (1.7 mm) thick polyvinyl chloride (PVC). Miter cut and fusion welded corners. Sash : 0.060 inch (1.5 mm) thick with fusion welded corners.

**** NOTE TO SPECIFIER ** Delete color options not required.**

2. Color: White Vinyl.
3. Color: Almond Vinyl.
4. Color: White Vinyl with Dark Bronze Exterior Finish - Painted.
5. Color: White Vinyl with Black Exterior Finish - Painted.
6. Color: Custom Exterior Finish - Painted.
As determined by the Architect.



▶ GRID STYLES & Sash Configurations

Simulated Divided Lites

For a dramatic and upscale look, choose the simulated divided lites (SDL) grid system which utilizes a pewter in-glass grid with grids applied on both the interior and exterior. Available for most Majesty Wood and vinyl windows.

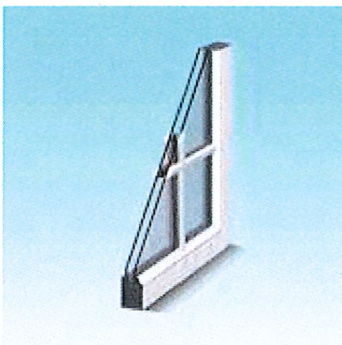

Vinyl

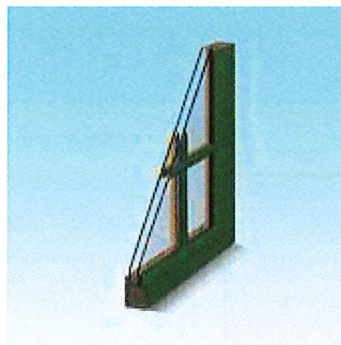

Majesty Wood

We use cookies to improve your browsing experience. By using this site, you accept our use of cookies.

ACCEPT & CLOSE

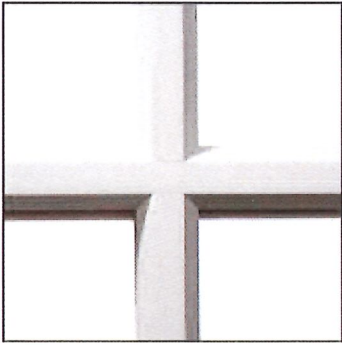

5/8" Grid

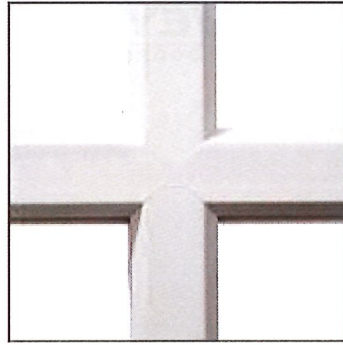

1" Grid

Exterior Applied

Exterior applied grids provide a more defined architectural style on the exterior, with the ease of grids between glass on the inside. Available for most vinyl windows.

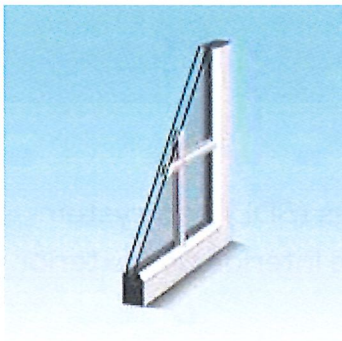

Vinyl

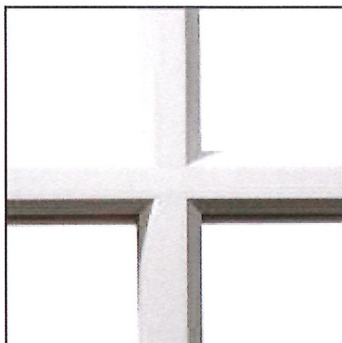

5/8" Grid

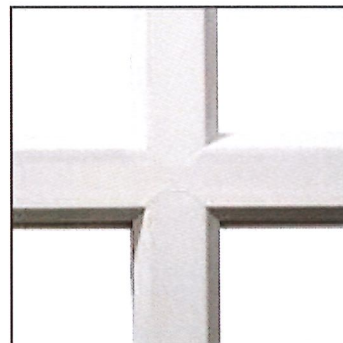

1" Grid

We use cookies to improve your browsing experience. By using this site, you accept our use of cookies.

ACCEPT & CLOSE

Color-matched contoured grids are positioned between the glass, allowing for easy cleaning. Available for most Majesty Wood and vinyl windows.

Pine interior snap-in grids are also available for Majesty Wood windows.



Vinyl

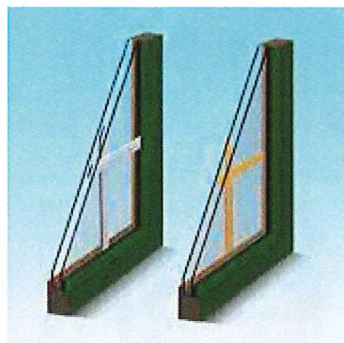

Majesty Wood

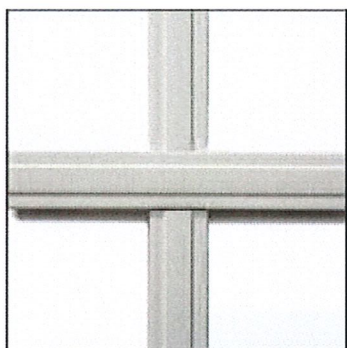

5/8" Contoured Grid

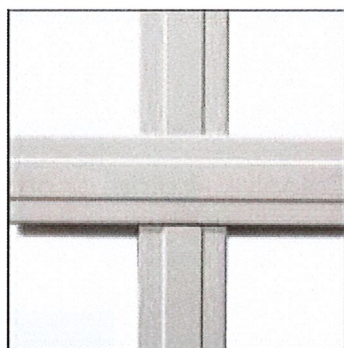

1" Contoured Grid

We use cookies to improve your browsing experience. By using this site, you accept our use of cookies.

ACCEPT & CLOSE



Configurations

Fully customize any grid design. Choose Colonial, Prairie, or other unique styles like Tudor or Gothic.

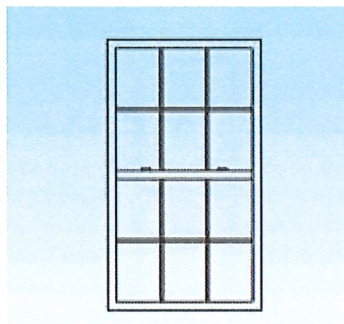

Colonial

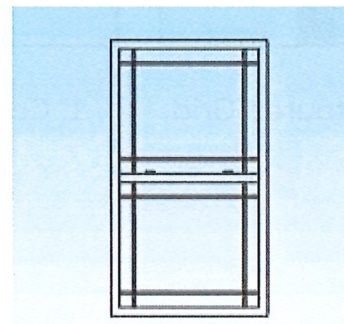

Prairie

We use cookies to improve your browsing experience. By using this site, you accept our use of cookies.

ACCEPT & CLOSE



▶ COLORS AND FINISHES

Stand out with a Pop of Color

Exterior Vinyl Finishes

In addition to White or Almond extruded vinyl windows and patio doors, Harvey offers a standard and custom exterior paint spectrum backed by a 10-year limited warranty against cracking, peeling or discoloration.

The water-based coatings contain special pigments to withstand temperature fluctuations while retaining vibrant color. With no toxic hardeners, the finish is durable while exceeding environmental and performance standards.



Looking for something special? We offer custom color matching.

We use cookies to improve your browsing experience. By using this site, you accept our use of cookies.

ACCEPT & CLOSE



White Vinyl

Almond Vinyl

Stocked Paint Colors

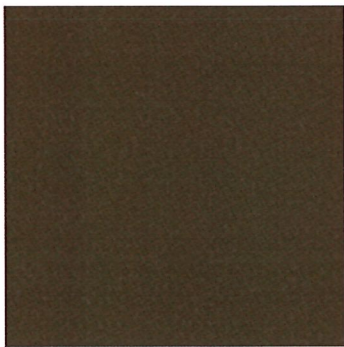

Dark Bronze

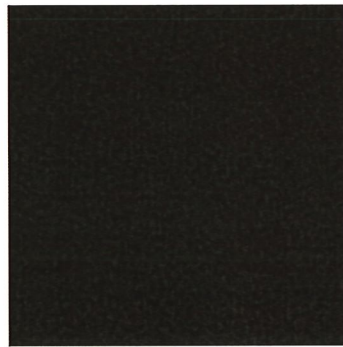

Black

Standard Paint Colors

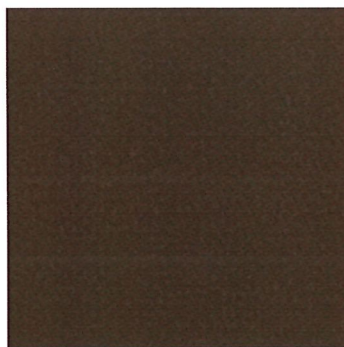

Universal Brown

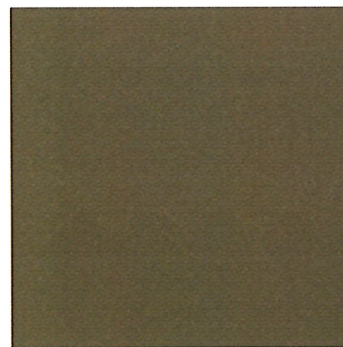

Bronze

We use cookies to improve your browsing experience. By using this site, you accept our use of cookies.

ACCEPT & CLOSE